

SECTION A-A

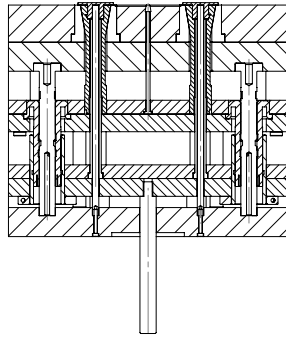

SECTION B-B

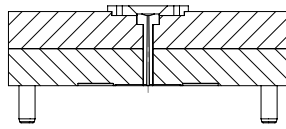
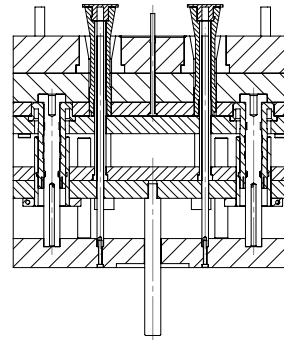
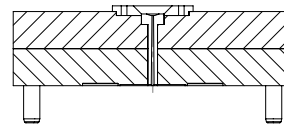

SECTION C-C

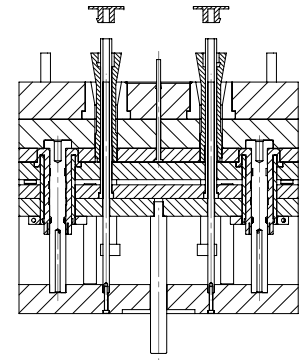
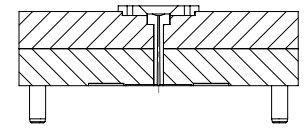

SECTION D-D

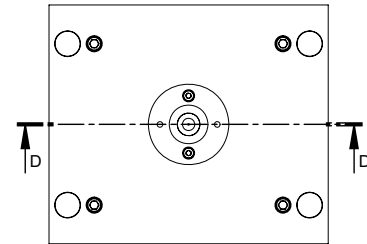
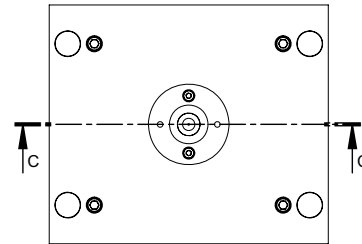
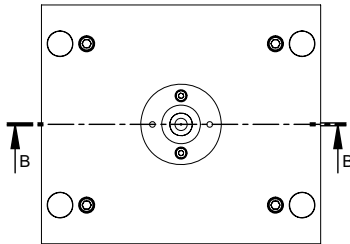
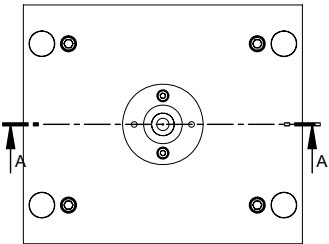

**TWO STAGE EJECTOR BOTTOM LAST - TSBL
APPLICATION EXAMPLE 1B**