

Hydraulic Unscrewing Device Assembly

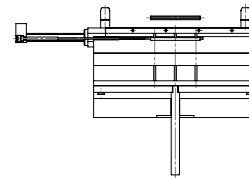

Application D Long Guiding Cores

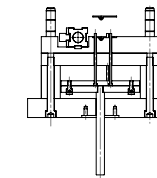
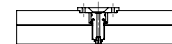
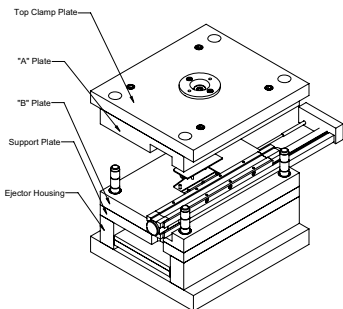
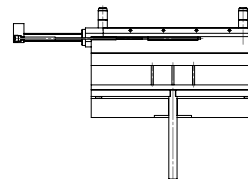
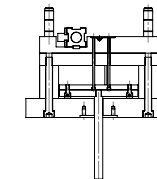
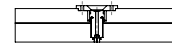
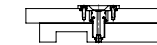
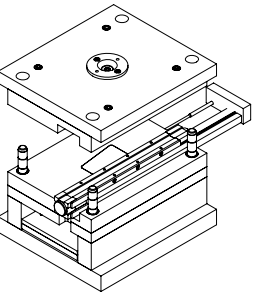
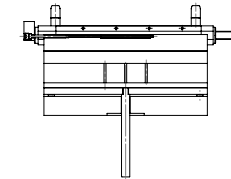
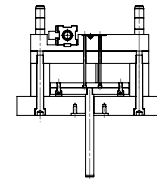
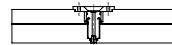
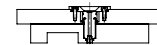
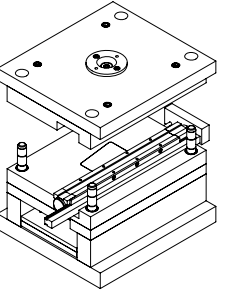
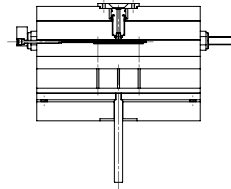
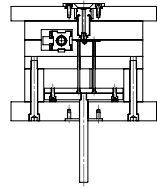
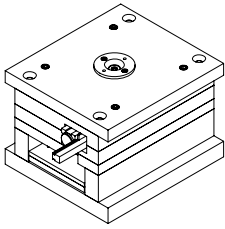
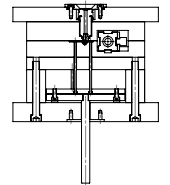
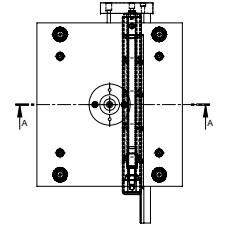

SECTION A-A